

Brioso

BR 4051 L/R

Montaj Kılavuzu

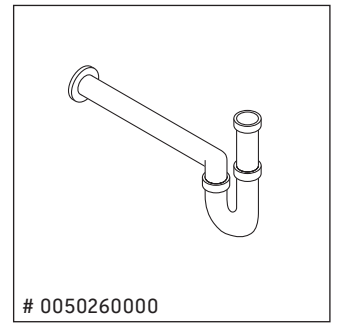
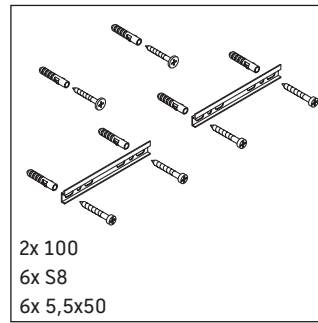
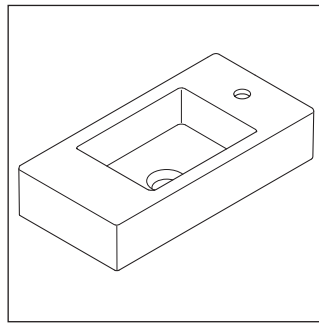
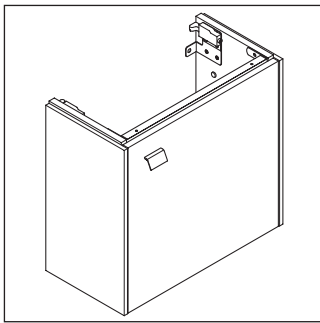
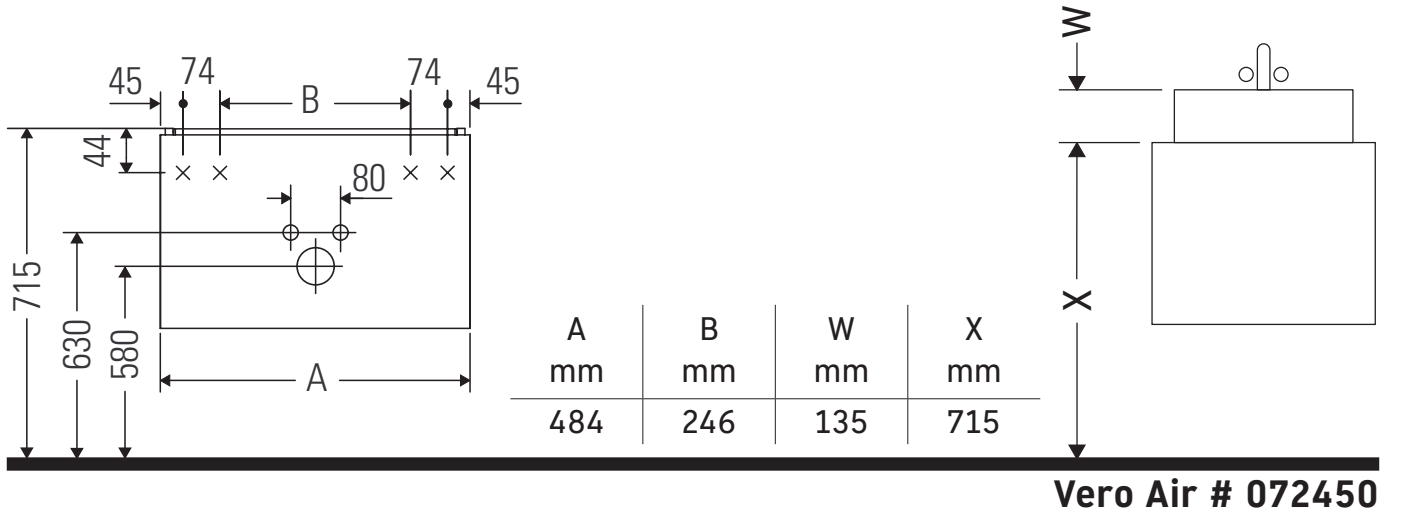

Kullanımla ilgili açıklamalar

Banyo mobilyası serisi teslimat sırasında geçerli olan standartlara ve direktiflere uygundur ve banyolar içinde kullanım için tasarlanmıştır. Banyo mobilyasının, örn. duş alınırken doğrudan suyla temas etmesi önlenmelidir.

Resimlerde gösterilen ürünlerde teknik iyileştirme ve görünüm değişiklikleri yapma hakkımız saklıdır.

