

Duravit AG
Werderstr. 36
78132 Hornberg
Germany
Phone +49 7833 70 0
Fax +49 7833 70 289
info@duravit.com
www.duravit.com

Leben im Bad
Living bathrooms

DURAVIT

Starck 3

Asia
Duravit Asia Limited
Unit 3408B, 34/F, AIA Tower
183 Electric Road
North Point,
Hong Kong
Phone +852 2219 8780
Fax +852 2219 8893
info@hk.duravit.com
www.duravit.com

Austria
Duravit Austria GmbH
Industriezentrum NÖ-Süd
Straße 2a/M38
2355 Wiener Neudorf
Phone +43 2236 677 033 0
Fax +43 2236 677 033 10
info@at.duravit.com
www.duravit.at

Belgium / Luxembourg
Duravit BeLux S.p.a./B.v.b.a.
83, Rue des Combattants
1310 La Hulpe
Phone +32 2 6560510
Fax +32 2 6560515
info@be.duravit.com
www.duravit.be

China
Duravit Shanghai Sales Center
Suite B-D
10/F, Jiushi Tower
No. 28 Zhongshan Road South
Shanghai 200010
Phone +86 21 6330 9922
Fax +86 21 6330 4807
info@cn.duravit.com
www.duravit.cn

CIS
Duravit CIS
Repr. Office Moscow
Proezd Serebryakova, 6
Moscow 129343
Phone +7 495 782 12 66
Fax +7 495 782 12 67
info@ru.duravit.com
www.duravit.com

Czech Republic/Slovakia
Duravit CZ
Přímětická 52
669 01 Znojmo
Phone +420 515 220 155
Fax +420 515 220 154
duravit.cz@tiscali.cz
www.duravit.com

Denmark
Duravit Danmark
Jegstrupvej 6
8361 Hasselager
Phone +45 8626 6000
Fax +45 8626 6001
info@dk.duravit.com
www.duravit.dk

Egypt
Duravit Egypt
20 Salah Salem Street
Heliopolis - Cairo
Phone +2 02 24175631
+2 02 24175632
Fax +2 02 4153702
duravit.egypt@eg.duravit.com
www.duravit.com

France
Duravit S.A.
Rue de Marienthal B.P. 30010
67241 Bischwiller Cedex
N° Indigo +33 820 820 414
Fax +33 388 906 101
info@fr.duravit.com
www.duravit.fr

Hungary
Duravit AG Magyarországi Képviselet,
Cím: 2083 Solymár, Panoráma u. 30.
Levelezési cím: 2083 Solymár, Pf. 77
Tel: +36 26 564465
Fax: +36 26 564466
info@hu.duravit.com
www.duravit.com

India
Duravit India Private Ltd.
B - 703, Shapath - 4
Opp. Karnavati Club
Sarkhej Gandhinagar Highway
Ahmedabad - 380051
Phone +91 79 6652 7444
Fax +91 79 6652 7333
info@in.duravit.com
www.duravit.com

Italy
Duravit Italia S.r.l.
Via Faentina 207 F
48100 Ravenna (RA)
Phone +39 0544 509711
Fax +39 0544 501694
info@it.duravit.com
www.duravit.it

Latin America
Duravit América Latina
Avda. del Libertador N°15.082, 1° piso
B1641ANH Acassuso
Buenos Aires
Phone +54 11 47434343
Fax +54 11 47434455
info@ar.duravit.com
www.duravit.com

Middle East
Duravit Middle East S.A.L.
Off Shore
Sodeco Square Building
Bloc B, 14th floor
Sodeco-Beirut
Lebanon
Phone +961 1 397330
Fax +961 1 397329
info@lb.duravit.com
www.duravit.com

Netherlands
Duravit Nederland B.V.
Ruwekampweg 2
5222 AT 's-Hertogenbosch
Phone +31 73 6131970
Fax +31 73 6100983
info@nl.duravit.com
www.duravit.nl

Norway
Duravit Norge
Strandveien 33
1366 Lysaker
Phone +47 815 33 600
Fax +47 815 33 601
info@no.duravit.com
www.duravit.com

Poland
Duravit AG Przedstawicielstwo w Polsce
Al. Krakowska 36 B
05-090 Warszawa/Raszyn
Phone +48 22 716 19 24
Fax +48 22 716 19 25
info@pl.duravit.com
www.duravit.com

Portugal
Duravit Portugal
Rua Antoine de Saint-Exupéry
Alapraia
2765-043 Estoril
Phone +351 21 466 7110
Fax +351 21 466 7119
duravit@jrb.pt
www.duravit.com

Spain
Duravit España S.L.
Pol. Ind. Sector Z
c/ de la Logística, 18
08150 Parets del Vallés
(Barcelona)
Phone +34 902 387 700
Fax +34 902 387 711
info@es.duravit.com
www.duravit.es

Sweden
Duravit Sweden AB
Svängatan 2 B
416 68 Göteborg
Phone +46 31 3375650
Fax +46 31 215140
info@se.duravit.com
www.duravit.com

Switzerland
Duravit Schweiz AG
Bahnweg 4
5504 Othmarsingen
Phone +41 62 887 25 50
Fax +41 62 887 25 51
info@ch.duravit.com
www.duravit.ch

Turkey
Duravit Yapı Ürünleri San. ve Tic. A.Ş.
Organize San. Böl.
10. Yol I-4 Parsel
34956 Tuzla/Istanbul
Phone +90 216 4585151
Fax +90 216 4585195
info@tr.duravit.com
www.duravit.com.tr

United Kingdom
Duravit UK Limited
Unit 7, Stratus Park
Brudenell Drive
Brinklow, Milton Keynes
MK10 0DE
Phone +44 845 500 7787
Fax +44 845 550 7786
info@uk.duravit.com
www.duravit.co.uk

USA
Duravit USA, Inc.
2205 Northmont Parkway
Suite 200 · Duluth, GA 30096
Phone +1 770 9313575
Fax +1 770 9318454
info@usa.duravit.com
www.duravit.us

Best.-Nr. 001263/54.04.08.5.0.1 - Printed in Germany - Gösterilen ürünlerin dış görünüşlerinde ve teknik özelliklerinde değişiklik ve geliştirme yapma hakkımız saklıdır.

DURAVIT



Philippe Starck bizi gereksinimin gereklilik olduđu bir dünyaya çekiyor; gösteriş ve etkileşimden uzak bir banyoya. Dahice hisleriyle dekorasyonun ve aksesuarların maskesini düşürerek aslında ne için gerekli olduklarını gösteriyor: Kitsch. Bu çalışmalarını Starck 1 ve Starck 2 serileri - bir tasarımcının minimalizm üzerine sempozyumunun Duravit tarafından uygulanması - ile kanıtlamıştır. Şimdi bir adım ileri gidiyoruz. Minimum fiyatla daha fazla ürün. Hem yeni kullanıcılara hem de profesyonellere. Mükemmel ve hatasız. Büyük ya da küçük projeler için - ofisler, okullar, oteller, hava alanları ve endüstriyel uygulamalar - ideal ve eksiksiz. Ve tabii ki eviniz için. Starck 3 her türlü mekan için uygun çözümleri tüm ulusal ve uluslararası standartları karşılayacak şekilde sunuyor. Starck 3. Mükemmel yaratmak.



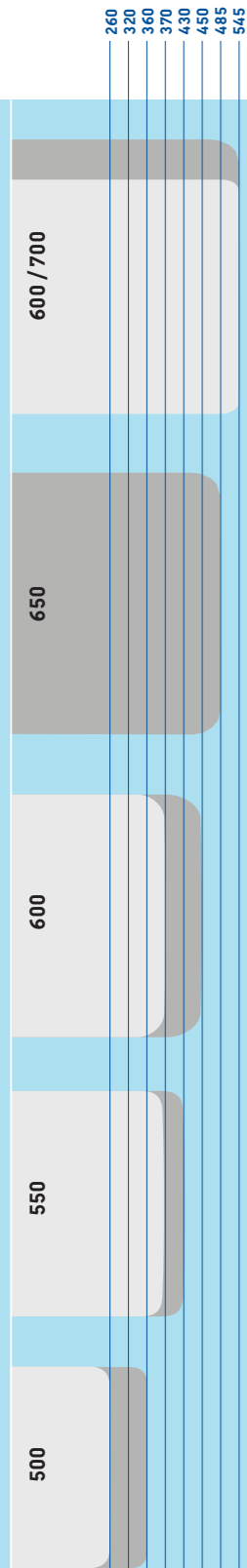

Bedensel engelli kullanımına uygun

- #0309700000 700 x 545 mm
- #0312700000 700 x 545 mm
- #0309600000 600 x 545 mm
- #0312600000 600 x 545 mm

Bedensel engelli kullanımına uygun

#0300650000 650 x 485 mm

Bedensel engelli kullanımına uygun

- #0300600000 600 x 450 mm
- #0307600000 600 x 450 mm
- #0301600000 600 x 370 mm

Bedensel engelli kullanımına uygun

- #0300550000 550 x 430 mm
- #0307550000 550 x 430 mm
- #0301550000 550 x 370 mm

Bedensel engelli kullanımına uygun

- #0300500000 500 x 360 mm
- #0307500000 500 x 360 mm
- #0751500000 500 x 260 mm

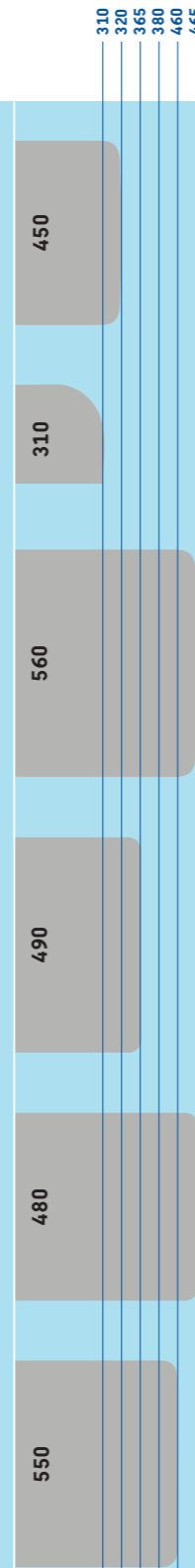

Bedensel engelli kullanımına uygun

#0750450000 450 x 320 mm

köşe lavabo

#0752440000 430 x 380 mm

Tezgah altı lavabo

#0302560000 560 x 465 mm

Tezgah altı lavabo

#0305490000 490 x 365 mm

#0302490000 490 x 365 mm

Tezgah altı lavabo

#0303480022 480 x 465 mm

Yarım tezgah lavabo

#0310550000 550 x 460 mm

= Compact versiyonda genişlik aynı, sadece derinlik daha kısa.

= Med versiyonda lavabo taşıma deliği yok, armatür deliği ise isteğe bağlı açılabilir.

= bedensel engelli kullanımına uygun

= dikey çıkış

= yatay çıkış

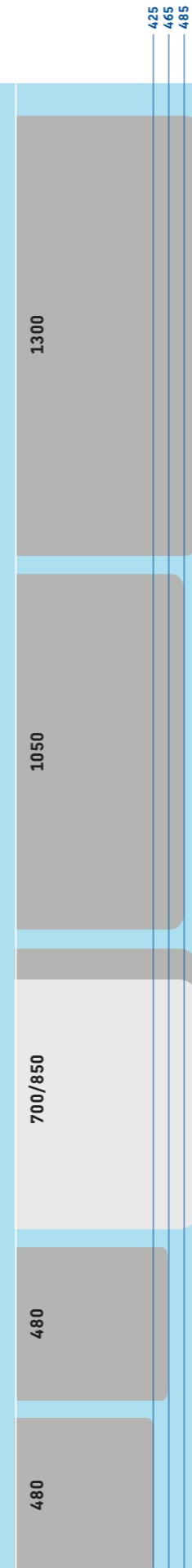

ikili lavabo

#0332130000 1300 x 490 mm

etejerli lavabo

#0304100000 1050 x 485 mm

etejerli lavabo

- #0304800000 850 x 490 mm
- #0304700000 700 x 490 mm

üstten gömme lavabo, etajerli lavabo krom konsolla uyumludur

#0306480000 480 x 465 mm

#0303480000 480 x 465 mm

lavabo

#0313480000 480 x 425 mm

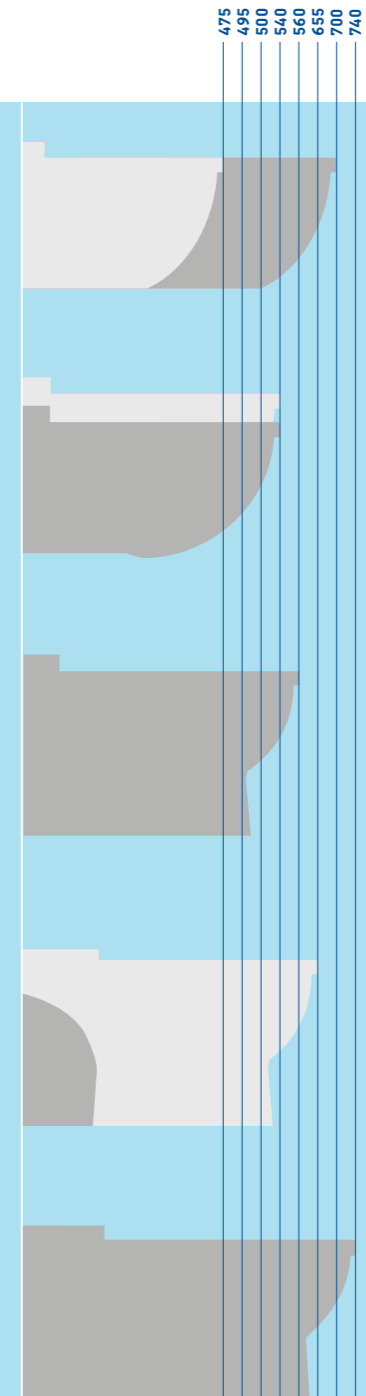

asma klozet / asma bide

- #2203090000
- #2202090000
- #2231150000 bide

asma klozet / asma bide

- #2200090000 asma klozet
- #2207090000 asma klozet
- #2206090000 asma klozet
- #2201090000 hastane tipi klozet
- #2215090000 klozet + 50 mm yükseltilebilir
- #2230150000 bide

yerden klozet vario / yere oturan bide

#0124090000 vario

#2230100000 bide

yerden klozet duvara dayalı / asma bide

- #0128090000
- yerden klozet
- #0126010000
- #0126090000
- #2234100000 bide ve değişken pis su çıkışlı klozet

klozet

#2104090000 vario





Sade güzellik: Dörtgen, yer tasarrufu sağlayan alçak arka panelli lavabo.

Kompakt ölçüler: 600 mm ve 500 mm genişlik için farklı derinliklerde akıllıca çözümler.

Tüm banyo çözümü: Tüm amaçlara, tüm ölçülere yönelik. Köşe lavabolardan, banyo lavabolarına kadar.

Pratik: Taşmasız Starck 3 Med serisi ve Kompakt serisi laboratuvar ve hastaneler için son derece uygun.

Parlak kombinasyonlar: X-Large and Starck 1.2.3 mobilya serileriyle uyumlu lavabo ve etajerli lavabo; yarım ayak veya kolon ayak ile.



Aynı ölçü farklı uygulama:solda 600 mm ölçüsünde Starck 3 lavabo sağda ise aynı lavabonun kompakt versiyonu.



Bir tasarımcının kaç detaya ihtiyacı vardır? Çizgi, daire ve dörtgen, tasarlanan objenin bir sezondan daha uzun süre kalıcı olması için gerekli öğelerdir. Philippe Starck bunu çok iyi biliyor - yeni banyo serisinde lüzumsuz hiçbir detay yok. Starck 3 lavabolar değişik karakterini dörtgen şeklinden, yuvarlak köşelerden ve alçak arka panelinden alıyor. Alışlagelmiş yuvarlak lavabolardan farklı olarak, dörtgen şekil yer tasarrufu sağlıyor. Güzel, dikkat çekici ve Starck.



Ürünlerin dahice karışımı: Starck 3 etajerli lavabo ihtiyacı olan tüm desteği ön cephesi Alüminyum olan Starck 1.2.3 dolap ünitesinden alıyor.

Starck 3 85 cm etajerli lavabo, X-Large mobilya serisinden Beyaz (Lake/Dekor) dolap ünitesi ile ve 70 cm lavabo koyu Venge (Dekor) X-Large ile.



Starck 3. Mükemmel yaratmak.





0300550000
550 x 430 mm



0304100000
1050 x 485 mm



0752440000
430 x 380 mm



0302560000
560 x 460 mm



0304800000
850 x 485 mm



0306480000
480 x 465 mm



0301600000
600 x 370 mm



0332130000
1300 x 485 mm



0751500000
500 x 260 mm



0304100000
1050 x 485 mm



0303480000
480 x 465 mm



0313480000
480 x 425 mm



0305490000
490 x 365 mm



0302490000
490 x 360 mm



0310550000
550 x 460 mm



0309600000
600 x 545 mm
0309700000
700 x 545 mm



0750450000
450 x 320 mm



0304700000
700 x 490 mm





Yeni Starck 1.2.3 banyo mobilyası tamamlayıcı ürünleri ile birlikte. "Az daha çoktur" felsefesi bu tamamlayıcı ürünlerde de aynı güzellikte devam ediyor.





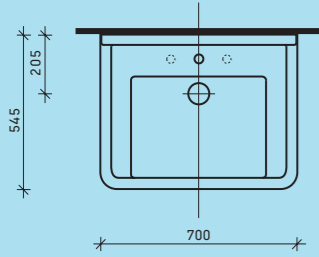



Starck 3. Mükemmeli yaratmak.

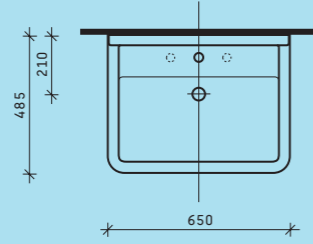

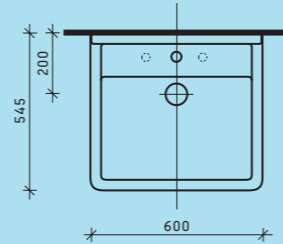

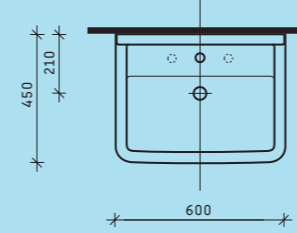
0309700000 
0312700000 

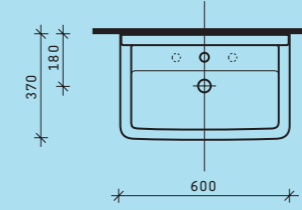
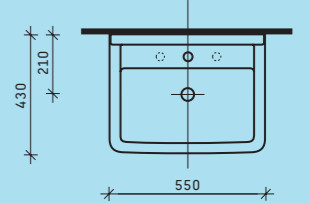

0300650000

# 0309600000 
0312600000 # 0300600000
0307600000 

0301600000 C

# 0300550000
0307550000 

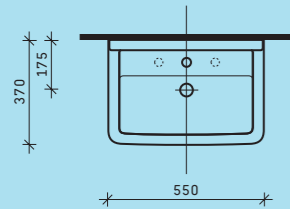
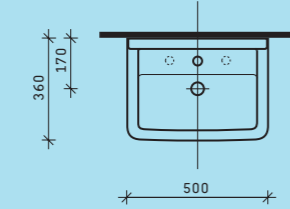
0301550000 C

# 0300500000
0307500000 

0750450000

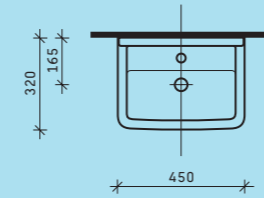

0751500000

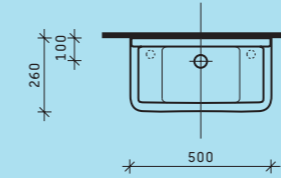

0752440000

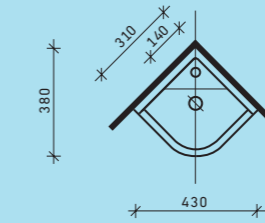
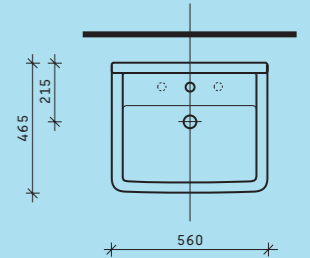
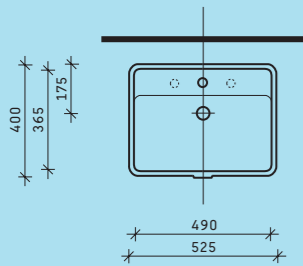
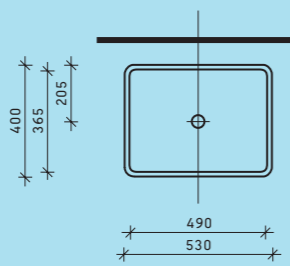
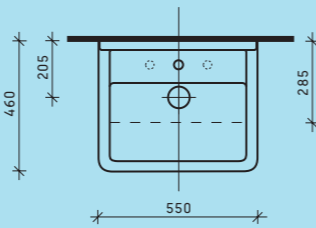
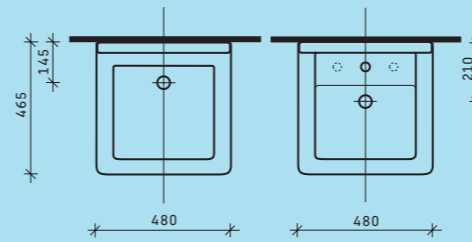
# 0302560000 # 0302490000 # 0305490000 # 0310550000 # 0306480000 # 0303480022 

0313480000

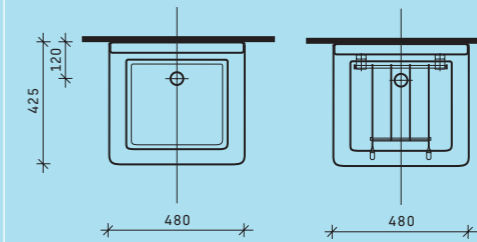

0332130000

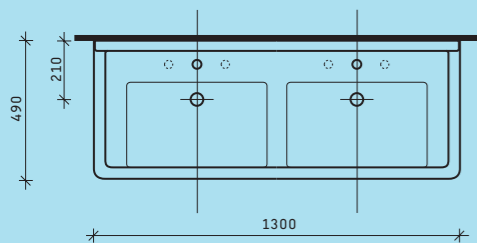

0304100000

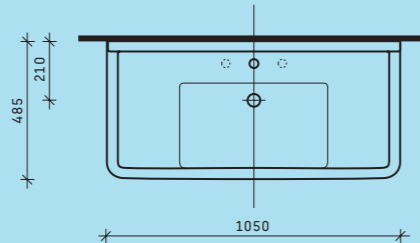



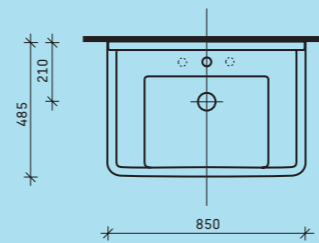

0304800000

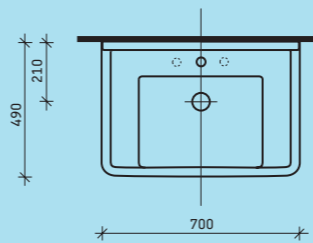

0304700000



C = Compact versiyonda genişlik aynı, sadece derinlik daha kısa.
 = Med versiyonda lavabo taşma deliği yok, armatür deliği ise is teğе başlı açılabilir.
 = bedensel engelli kullanımına uygun
 = alttan montaja uygun
 = üstten montaja uygun

Klozet: Banyonun tasarımcılar tarafından göz ardı edilmiş en temel ürününü Philippe Starck Duravit için değiştirdi. Diğer bütün ürünlere verilen önem Starck 3 klozetlerinde de hatasız olarak sunuluyor. Tabi ki mükemmel tasarımla beraber fonksiyonelliği de unutmamıştır: Tüm klozetlerde Dual-Flush sistemi ve hem yerden hem de asma alternatifli klozet ve bideler. Uyumlu seramik bölmesi ile pisuar bu geniş seriyi tamamlıyor. Sonuç olarak, Starck 3 tüm ihtiyaçları karşılıyor. Sadece kamusal alanlar için değil, kendi eviniz için de.



Güzel uyumlar: 3 ve 6 litre için Dual-Flush sistemli seramik rezervuarlar. Fazla su sarfiyatını önlemek için küçük düğmeye bir kere basmanız yeter.

Mükemmel uyum: Aynı tasarım, farklı fonksiyonlar. Tüm klozet ve bideler hem asma hem de yerden modeller ile.

Hatasız çözüm: Starck 3 yerden klozet, Büyük Klozet ve vario çıkışlı model.

Banyoda estetik: Özel menteşesi ile tamamen klozeti örten klozet kapağı serinin sade özelliğini vurguluyor.

Temiz Hava: Asma klozet ve bidelerdeki 80 mm. Lik yükseklik ile banyoda daha iyi temizlik

Rahatlık: Asma klozette + 50 mm daha yüksek oturma pozisyonu ile gerçek konfor. Etkileyici Big Toilet - Büyük Klozet soft close tekniğine sahip klozet kapağı ile rahatlık anlamında yeni standartlar getiriyor.

Kamusal Alan: Kamusal ve yarı kamusal alanlar için pisuar. Üstten veya arkadan su girişli, isteğe bağlı olarak sinekli.



Alternatif çok: örnek olarak, standart asma klozet ve bide (solda) ve kompakt modeller. Hepsinin yerden yüksekliği 80 mm.



Estetik fonksiyonellik ile birleşti (saat yönünde): asma klozet ve bide, compact asma klozet ve bide, yerden ve duvara dayalı klozetler.

Sol Sayfa: Konfort asma klozet yükseltilmiş oturma pozisyonu ile rahatlık anlamında gerçek bir gelişme sunuyor. Standart klozet ölçülerinden 50 mm daha yüksek oturma imkanı ile temiz su ve gider bağlantılarında değişiklik yapmadan uzun boylu ve yaşlı insanlara daha rahat oturma imkanı veriyor. Bu Sayfa: Etkileyici Big Toilet - Büyük Klozet soft-close tekniğine sahip klozet kapağı ile konfor anlamında yeni standartlar getiriyor.

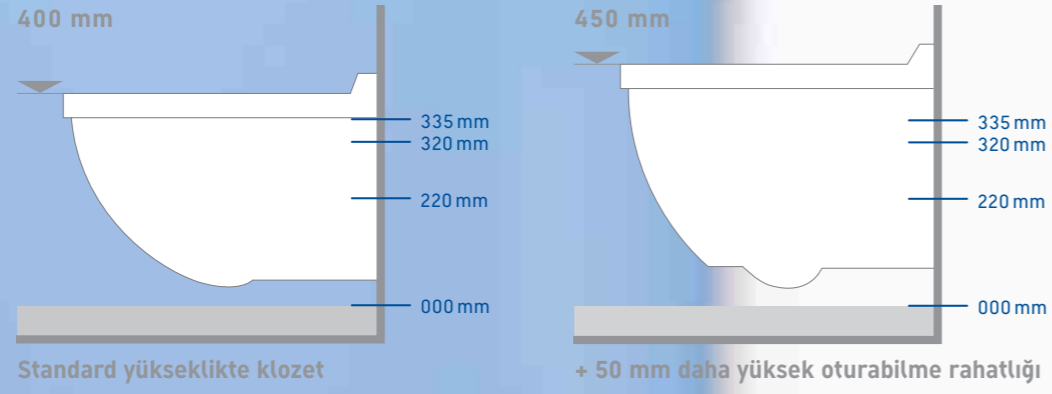

Anlamli bir ekleme: Özürlü kullanımına uygun 700 mm izdüşümlü klozet. 3 / 6 litre yıkama fonksiyonlu, çepeçevre yıkama kanalları ile kamusal ve yarı kamusal yarı umumi alanlarda kullanıma uygun. Yeni klozet kapağında kullanılan tek parça paslanmaz çelik menteşe diğer tüm Starck 3 serisi klozetleriyle de uyum sağlıyor.





Kamusal alanlar için ideal, soldan sağa saat yönünde: tamamen kapalı seramik yüzeyli ve yıkama kanallı yeni Pisuar, kişisel mahremiyet için seramik ara bölme, ve yeni Seramik 3 yerden klozet ile seramik kapaklı modeli. Solda: Üstten su girişli veya arkadan gizli su bağlantılı pisuar, opsiyonel olarak sinekli.



2200090000

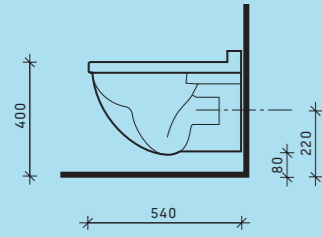

2201090000

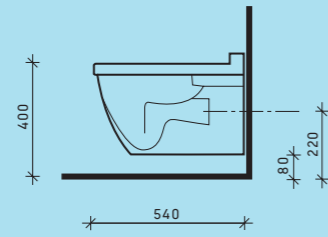

2207090000

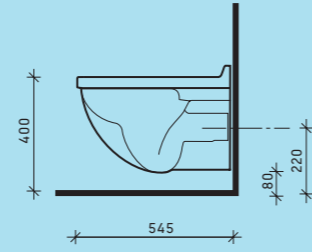

2230150000

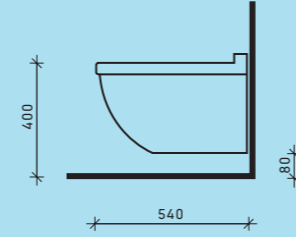

2202090000 C

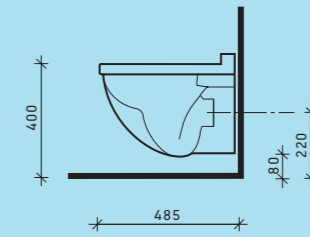

2231150000 C

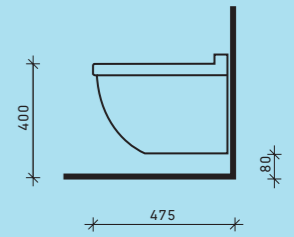

2206090000

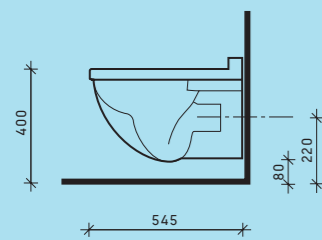

2215090000 + 50 mm

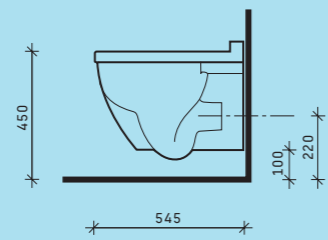

2203090000 ♿

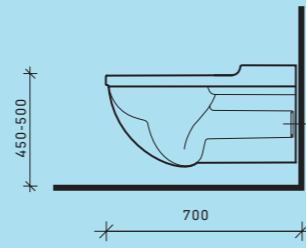

0126010000

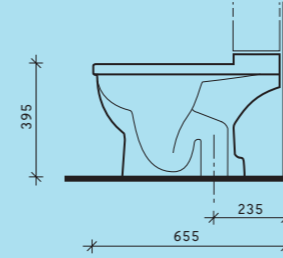

0128090000

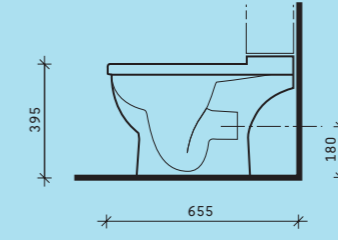

2234100000

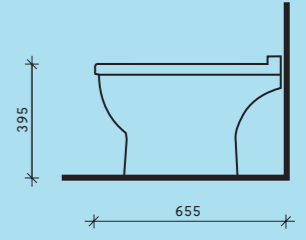

0128090000

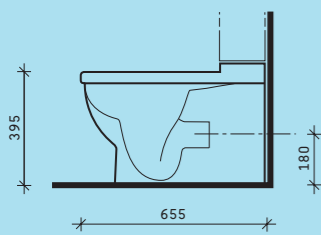

2104090000

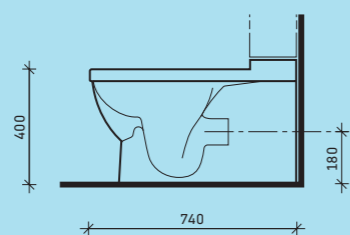

Vario klozetin çeşitli çıkışları
0128090000 / # 2104090000

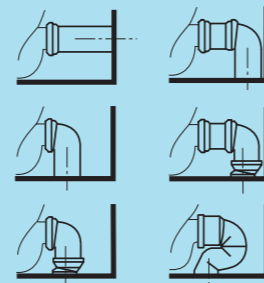

0124090000

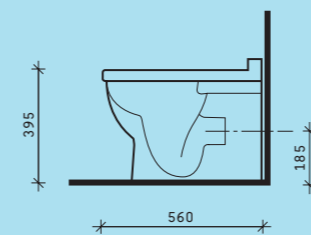

2230100000

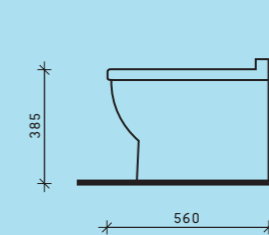

0821350000

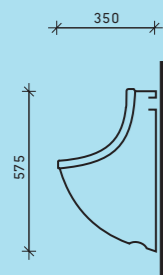

0822350000



0826250000

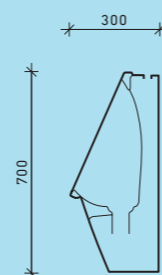

0827250000

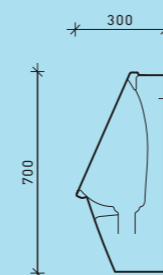

8500000000

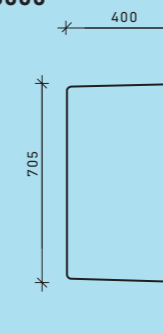

C = Kompakt model
♿ = bedensel engelli kullanımına uygun

Neden kısa boylu insanlar uzun boylu insanlara göre banyo yapmaktan daha çok keyif alırlar? Philippe Starck bu soruyu kendine sormuş ve tasarımla beraber daha fazla alan ve rahatlık sağlayan bir küvet geliştirmiştir. Optimal alan çözümü ve geliştirilmiş sırt dayama sistemi ile artık insanlar bedenlerinin herhangi bir yeri küvetin dışında ve kuru kalmadan banyo keyiflerini tamamlayabilecekler. İster hidromasajlı, ister hidromasajsız Starck 3 küvetlerle her banyodan sonra kendinizi yeniden doğmuş gibi hissedeceksiniz. Kare, dörtgen, beşgen veya çeyrek daire seçenekleriyle duş teknelerini de unutmayın. Bu ürün çeşitliliğinde de Philippe Starck'ın tasarım vizyonu her zaman göze çarpıyor: bir banyo yaratıcılığı. Pürüzsüz, temiz ve tabii ki rahat.

Geniş iç hacim: minimal dış ölçülerdeki küvet, maksimum iç hacim ve rahatlığı sunuyor.Hatta iki kişi için bile.

Biçim çeşitliliği: on bir küvet, bir tasarım. 150 cm'den 200 cm'e değişen ölçüler.

Köpüren rahatlık: hava sistemli, su jeti sistemli veya kombine hava ve su jeti sistemli hidromasaj Combi-System P ve Combi-System E.

İsteğe göre ilave konfor alternatifleri:

Ayak ve sırt masajı sistemleri, ayarlanabilir dönen jetler, gömme ısıtıcılarla ayarlanan su derecesi. Dinlendirici bir atmosfer sağlayan halojen aydınlatma elemanları.

Tamamlayıcı şekiller: Starck 3 duş tekneleri, kare, dörtgen, beşgen veya çeyrek daire şeklinde. Ankastre veya entegre panel.

Titiz temizlik: üzerindeki standart ekipman tüm sistem drenajını sağlamakta. İstek üzerine tüm sistem özel hijyen işletim sistemi ile donatılabilir.

Rahatlık: sırt dayama alanı,entegre baş dayaması ile beraber ekstra uzunluktadır. İlave rahatlık: Yumuşak-Kafa dayama-hijyenik, kolay temizlenen sentetikten imal edilmiştir.

Doğal görüntü: Amerikan Ceviz, Venge, Macassar, Amerikan Kiraz, Zeytin Dişbudak, Teak, Doğal kursun rengi, Doğal kireçli, Meşe ve Makore tonlarında ahşap küvet panelleri.



Değişik modeller, (saat yönünde): temel Starck 3 duş teknesi modelleri, çeyrek daire, beşgen, kare, dörtgen. Bütün duş tekneleri akrilikten üretilmiş olup, ankastre seçenekleri de vardır. Beşgen model entegre panel seçeneğine de sahiptir.



Tek başınıza veya beraber banyo yapmanın rahatlığı: solda iki kişilik Starck 3 küveti, hidromasajlı, 1800x800 mm, Combi-System E, hijyen işletimi sistemi ve yumuşak kafa dayamarsı ile beraber, sağda tek kişilik model, 1700 x 750 mm. Combi-System E ile donatılmış ayak masajı ve aydınlatma ilave sistemleri kullanılmış.



Hoş değişimler: dokunulduğunda Combi L System küvetlerin kumanda paneli mavi bir tonla aydınlanıyor.(küçük resimler orta ve sağ)

700091 1500 x 700 mm
700092 1500 x 750 mm

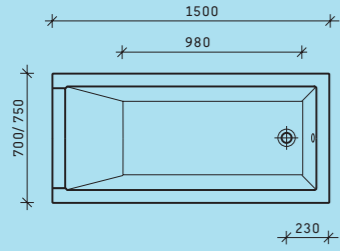

700001 1600 x 700 mm

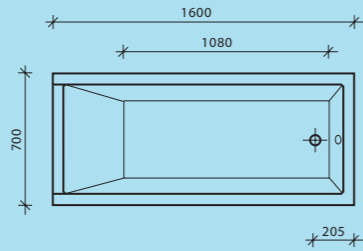

700002 1700 x 700 mm
700003 1700 x 750 mm

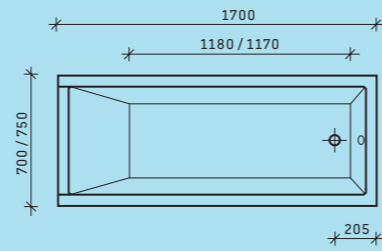

700117 1700 x 800 mm
700118 1700 x 900 mm

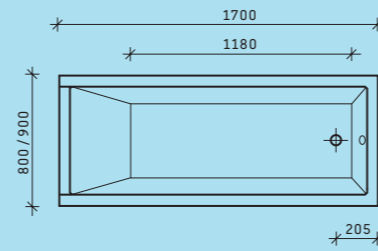

700004 1800 x 800 mm
700119 1800 x 900 mm

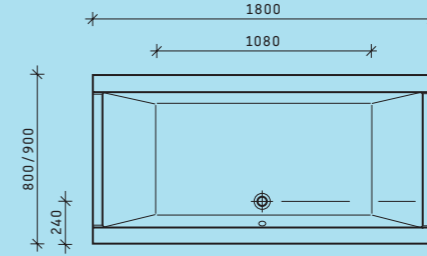

700031 1900 x 900 mm

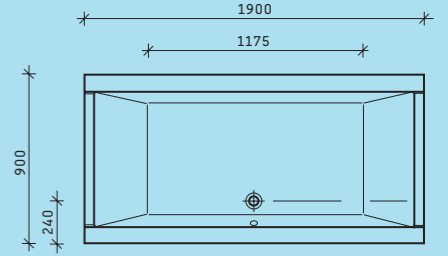

700032 2000 x 1000 mm

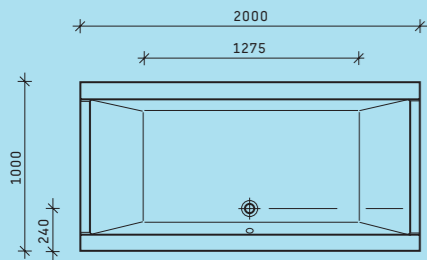

720005 900 x 900 mm
720006 900 x 900 mm*

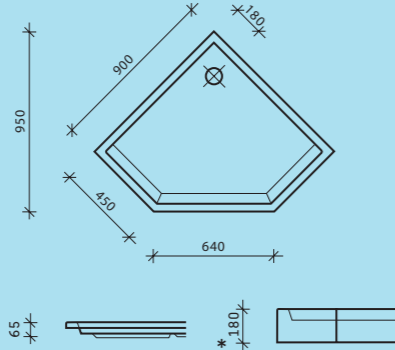

720007 1000 x 1000 mm
720008 1000 x 1000 mm*

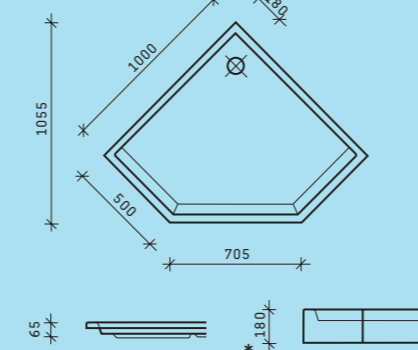

720030 900 x 900 mm

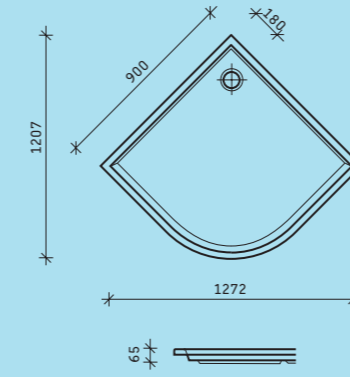

720032 1000 x 1000 mm

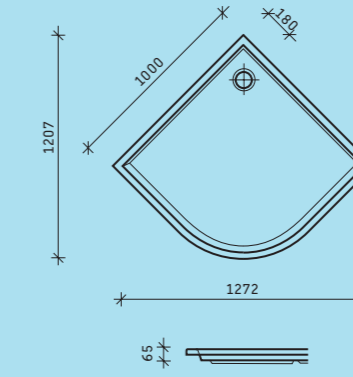

720009 800 x 800 mm
720010 900 x 900 mm
720011 1000 x 1000 mm

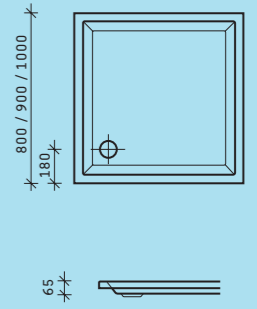

720012 900 x 750 mm
720013 900 x 800 mm

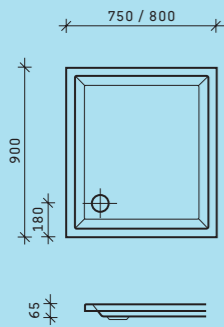

720014 1000 x 800 mm
720015 1000 x 900 mm

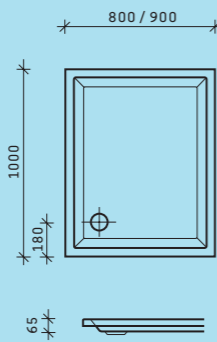

720016 1200 x 800 mm
720017 1200 x 900 mm
720018 1200 x 1000 mm

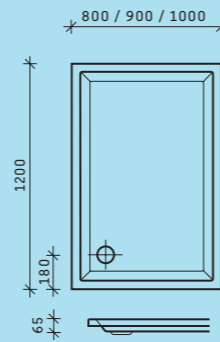

720034 1400 x 700 mm
720019 1400 x 750 mm
720035 1400 x 900 mm

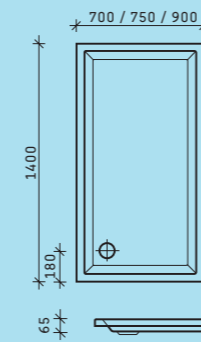

720036 1500 x 700 mm
720037 1500 x 750 mm

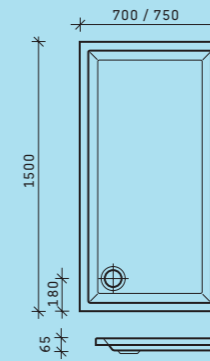

720038 1600 x 700 mm
720039 1600 x 750 mm
720040 1600 x 900 mm

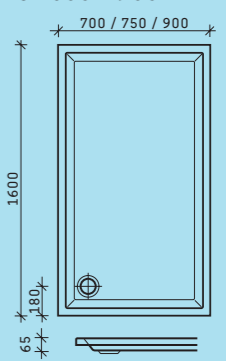

720061 1700 x 750 mm
720041 1700 x 900 mm

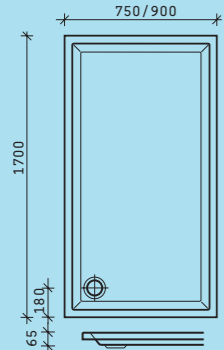

720042 1800 x 900 mm

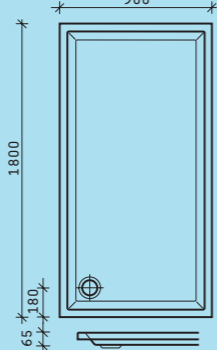

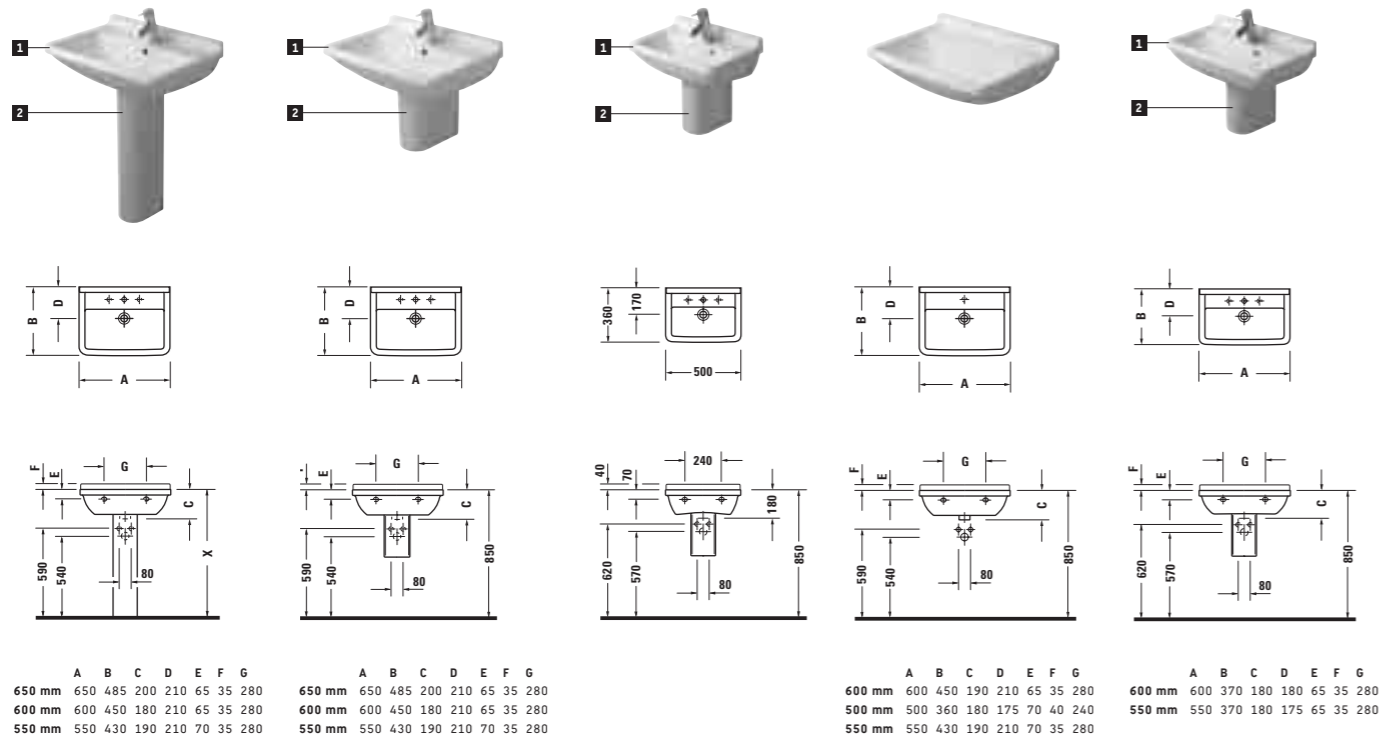

- 1 # 0300650000 ● ○ ○
- 2 # 0300600000 ○ ● ○
- 3 # 0300550000 ○ ● ○
- 4 # 0865160000
- 1 # 0300650000 ○ ● ○
- 2 # 0300600000 ○ ● ○
- 3 # 0300550000 ○ ● ○
- 4 # 0865150000
- Med
- 1 # 0307600000 ●
- 2 # 0307500000 ●
- 3 # 0307550000 ●
- Compact
- 1 # 0301600000 ○ ● ○
- 2 # 0301550000 ○ ● ○
- 3 # 0865170000

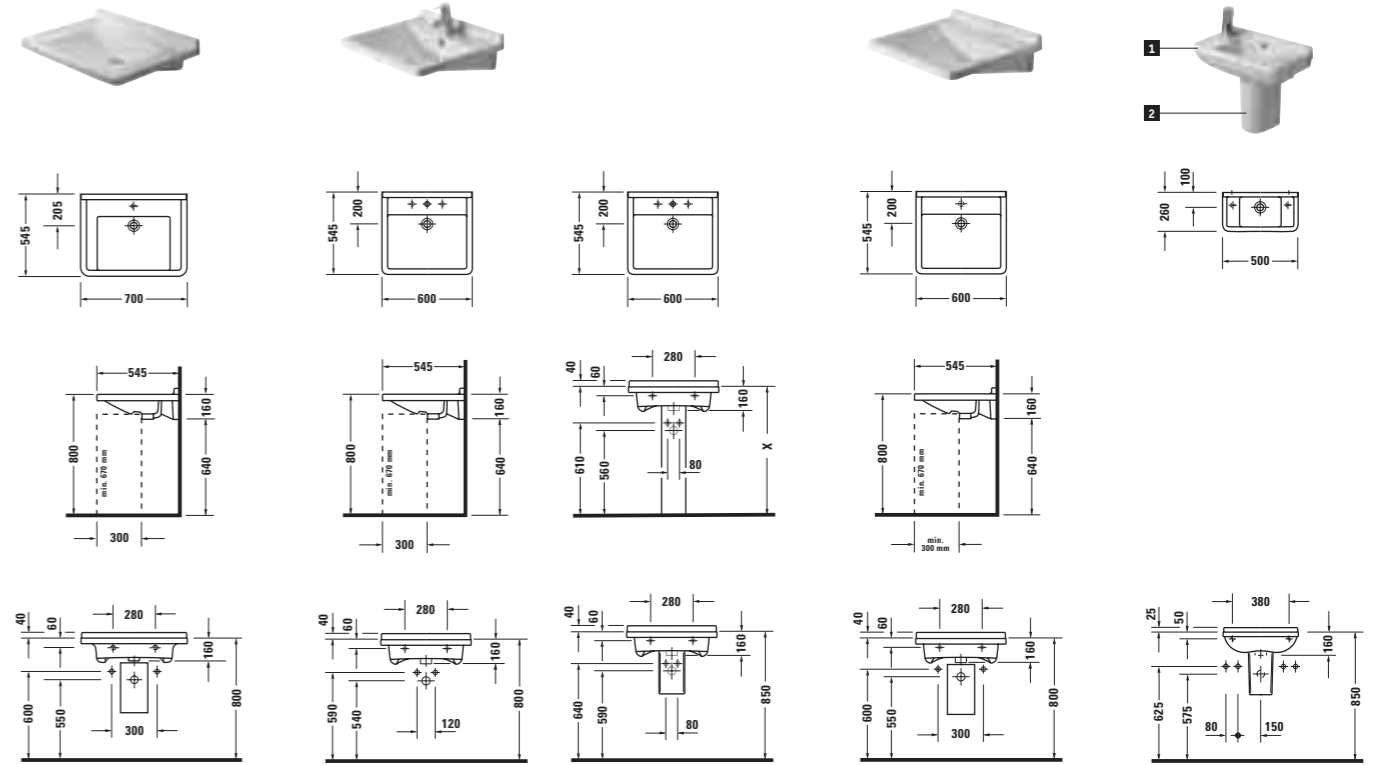

- Bedensel engelli kullanımına uygun
- 1 # 0312700000 ●
- 2 # 0309600000 ○ ● ○
- Geberit sifon 151.110.11.1
- Bedensel engelli kullanımına uygun
- 1 # 0865160000
- 2 # 0865150000
- Bedensel engelli kullanımına uygun
- 1 # 0312600000 ●
- 2 # 0865180000
- Geberit sifon 151.110.11.1

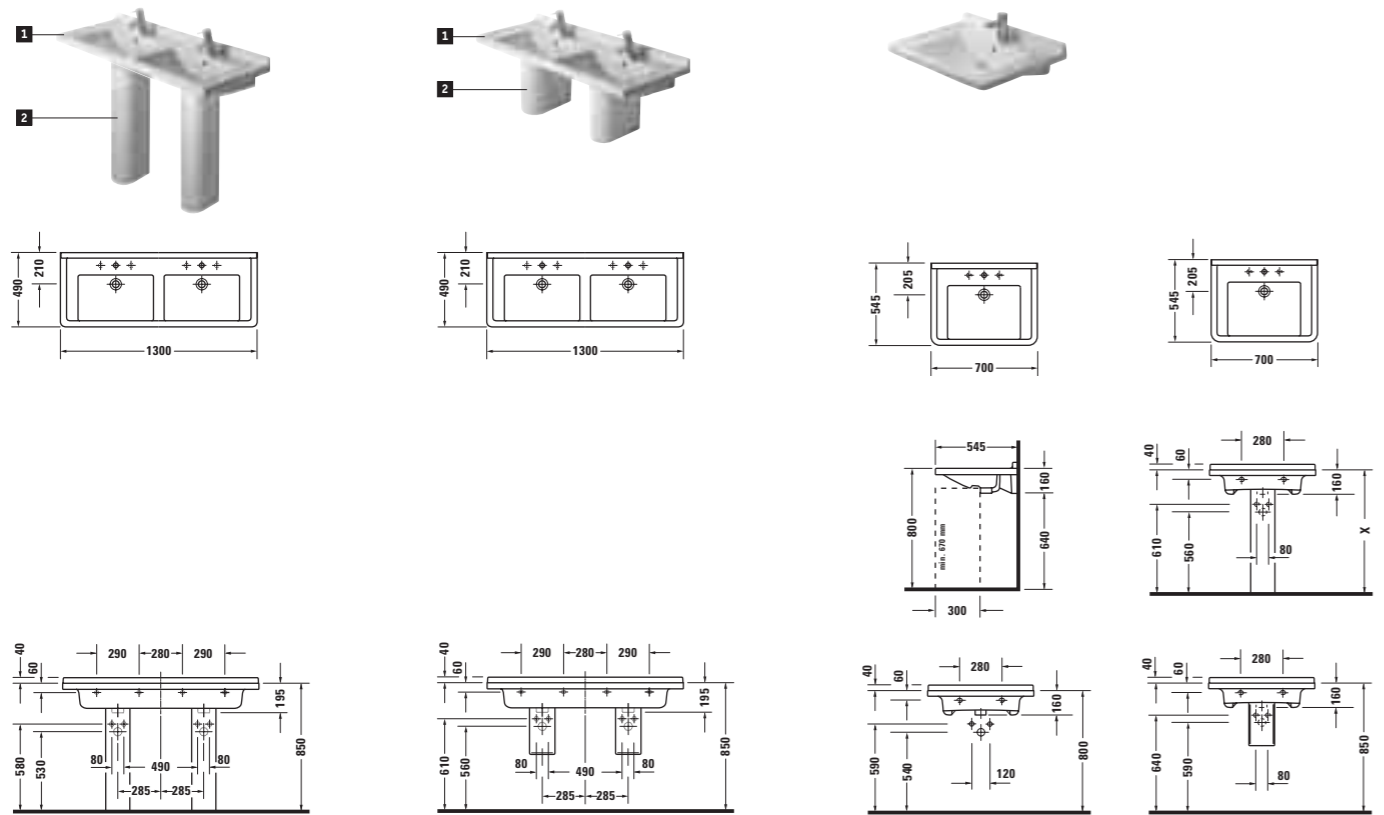

- 1 # 0332130000 ● ●
- 2 # 0332130030 ● ● ●
- 3 # 0865160000
- Bedensel engelli kullanımına uygun
- 1 # 0332130000 ●
- 2 # 0332130030 ● ● ●
- 3 # 0865160000
- Bedensel engelli kullanımına uygun
- 1 # 0309700000 ○ ● ○
- 2 # 0865160000
- 3 # 0865150000

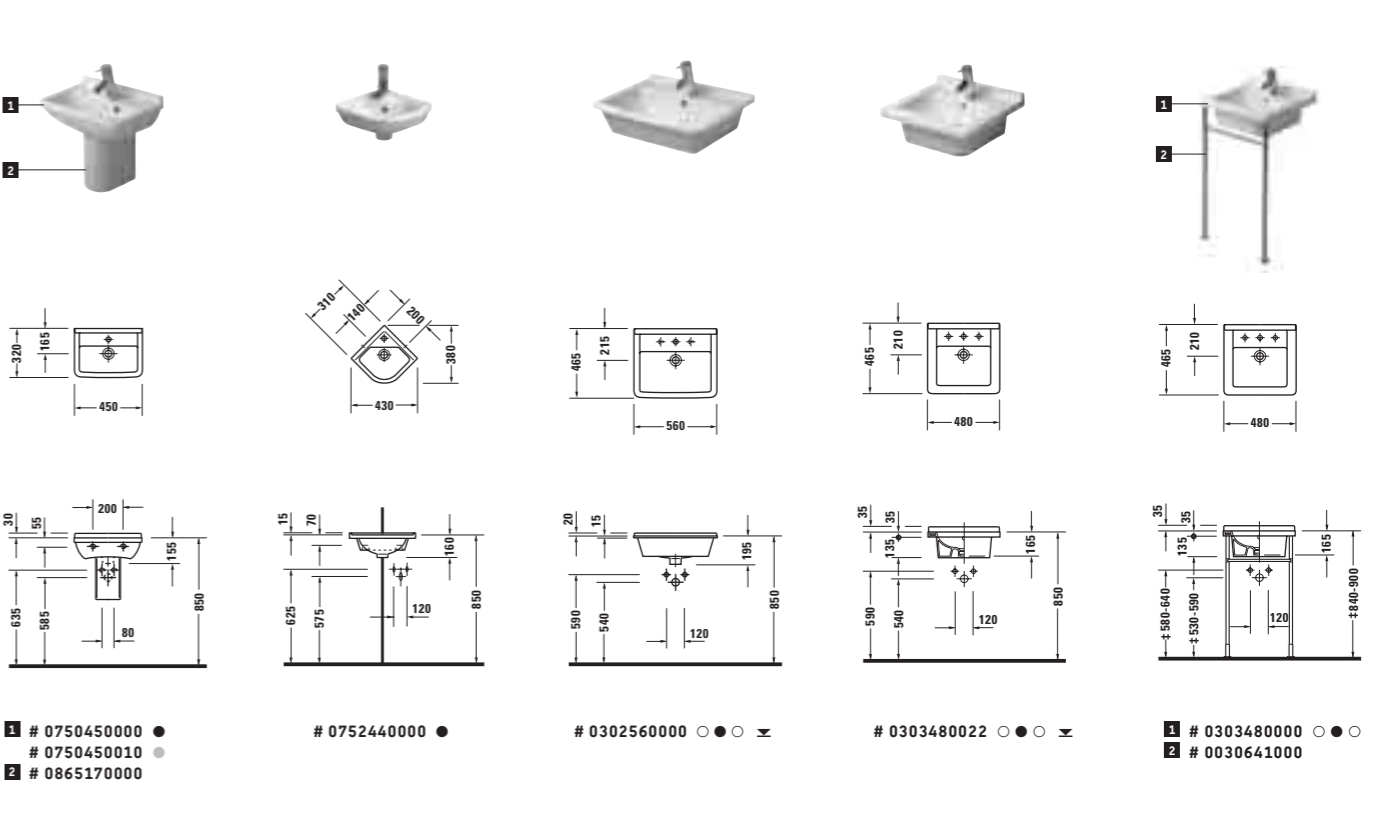

- 1 # 0750450000 ●
- 2 # 0750450010 ●
- 3 # 0865170000
- Bedensel engelli kullanımına uygun
- 1 # 0752440000 ●
- 2 # 0302560000 ○ ● ○
- 3 # 0303480022 ○ ● ○
- 4 # 0303480000 ○ ● ○
- 5 # 0030641000

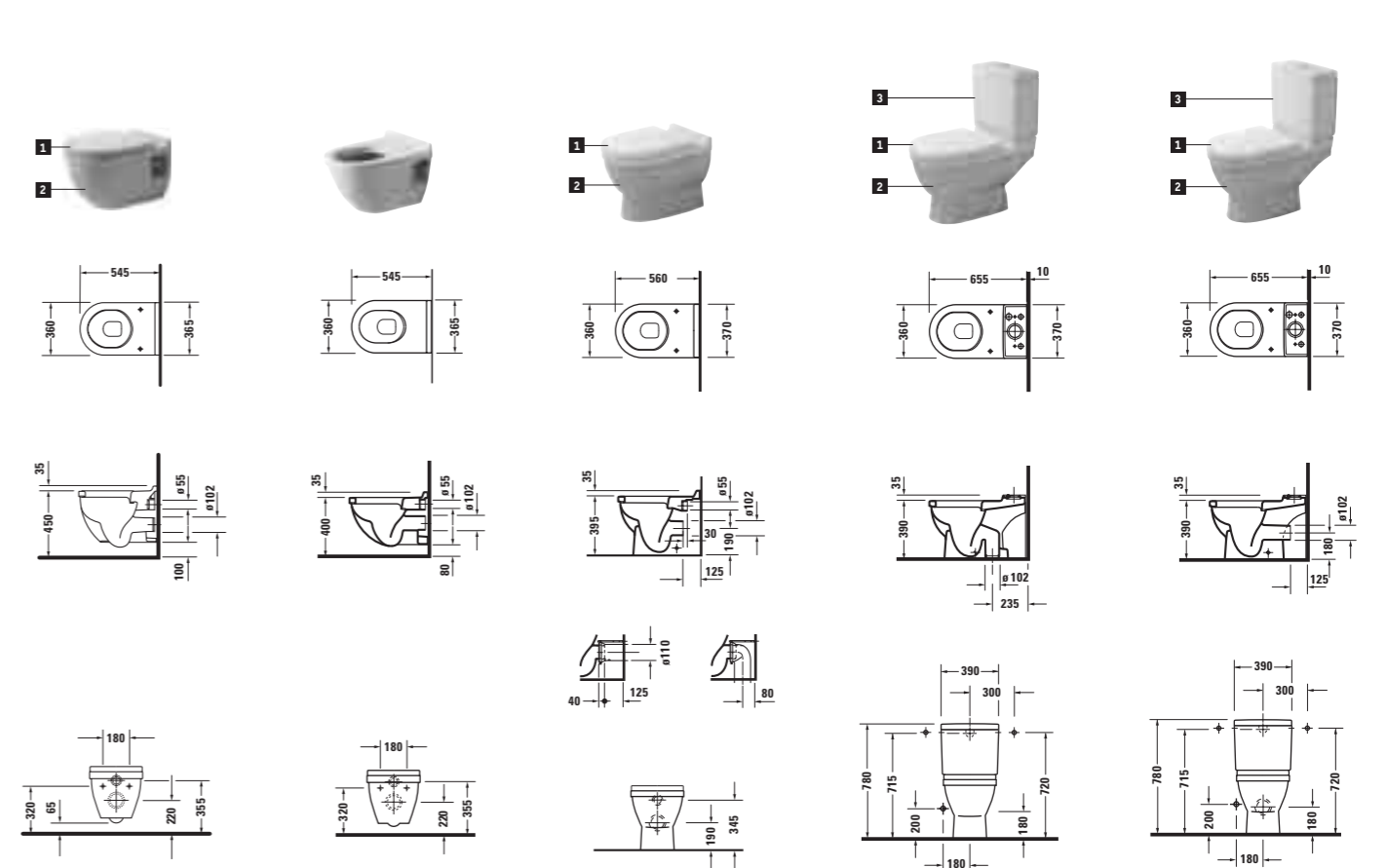
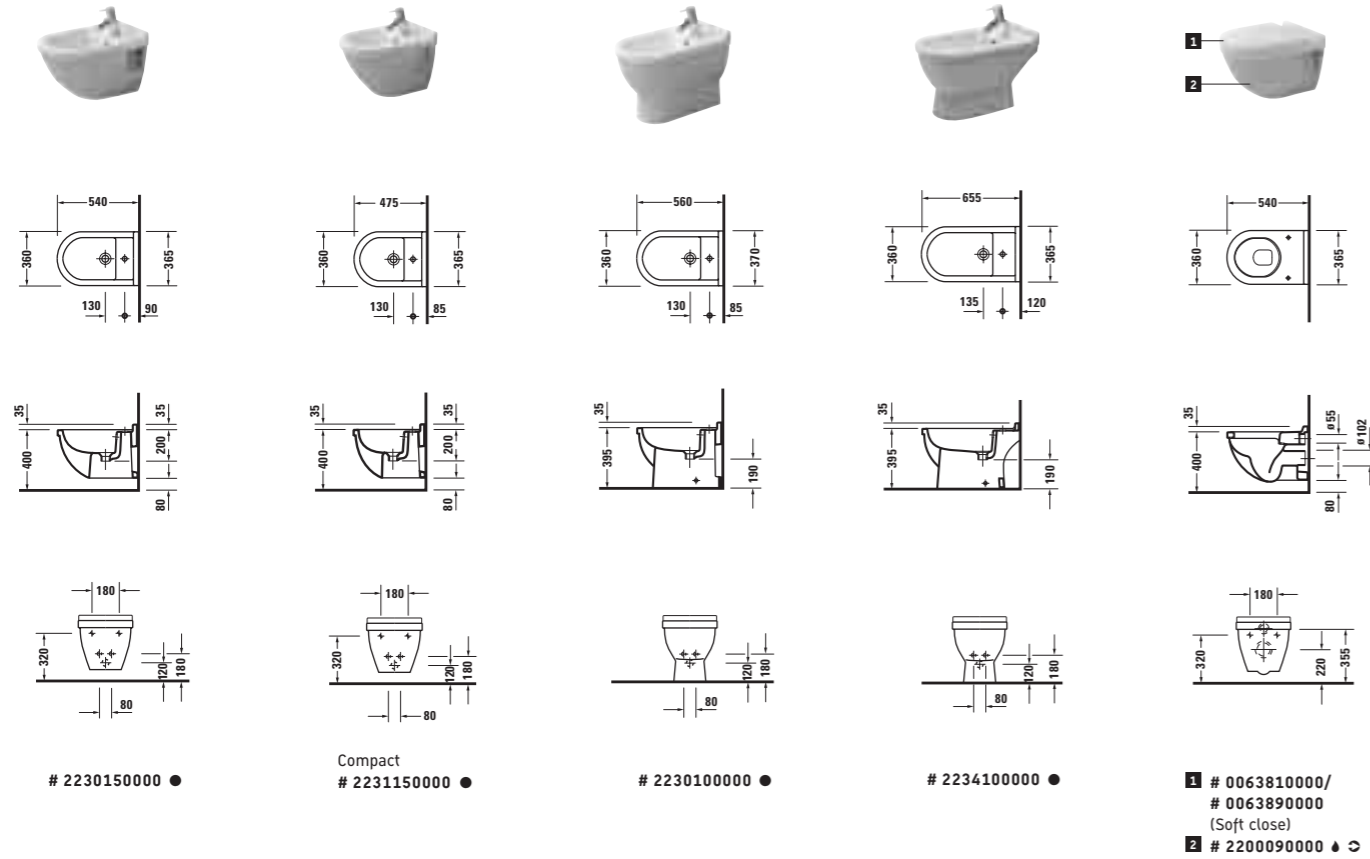
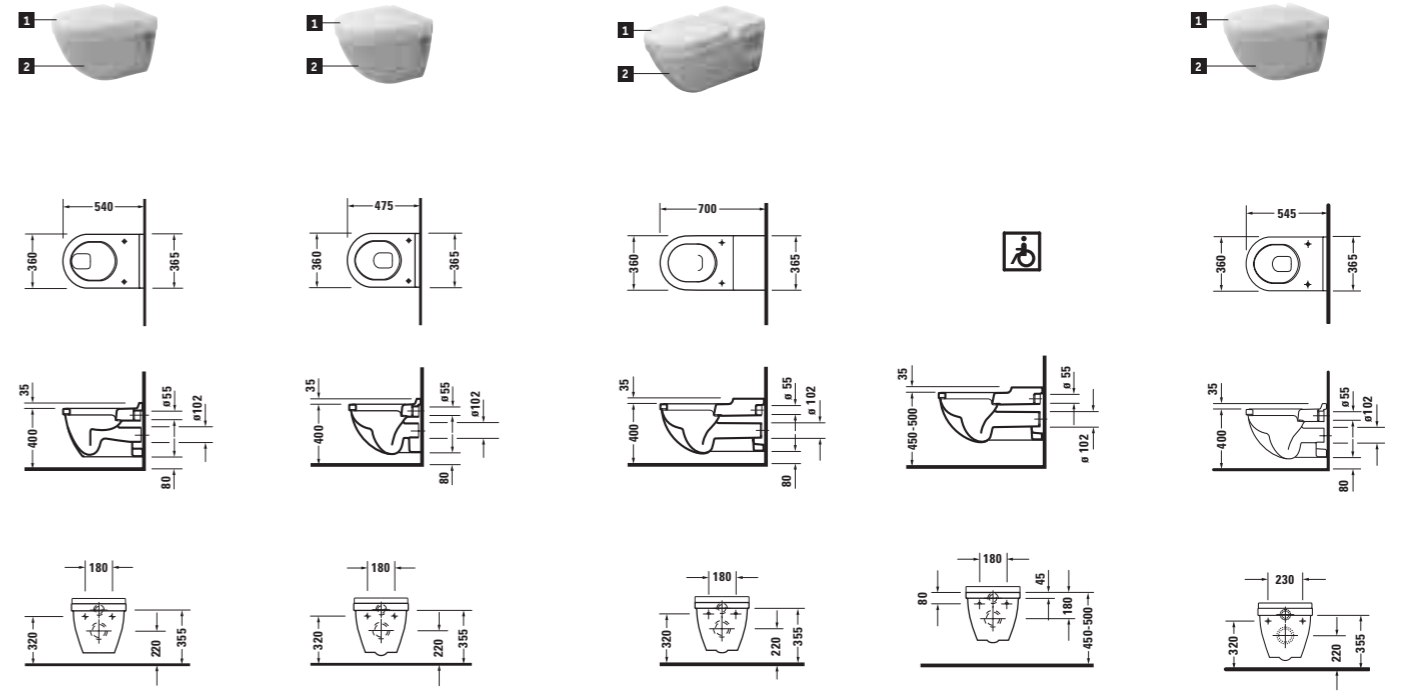
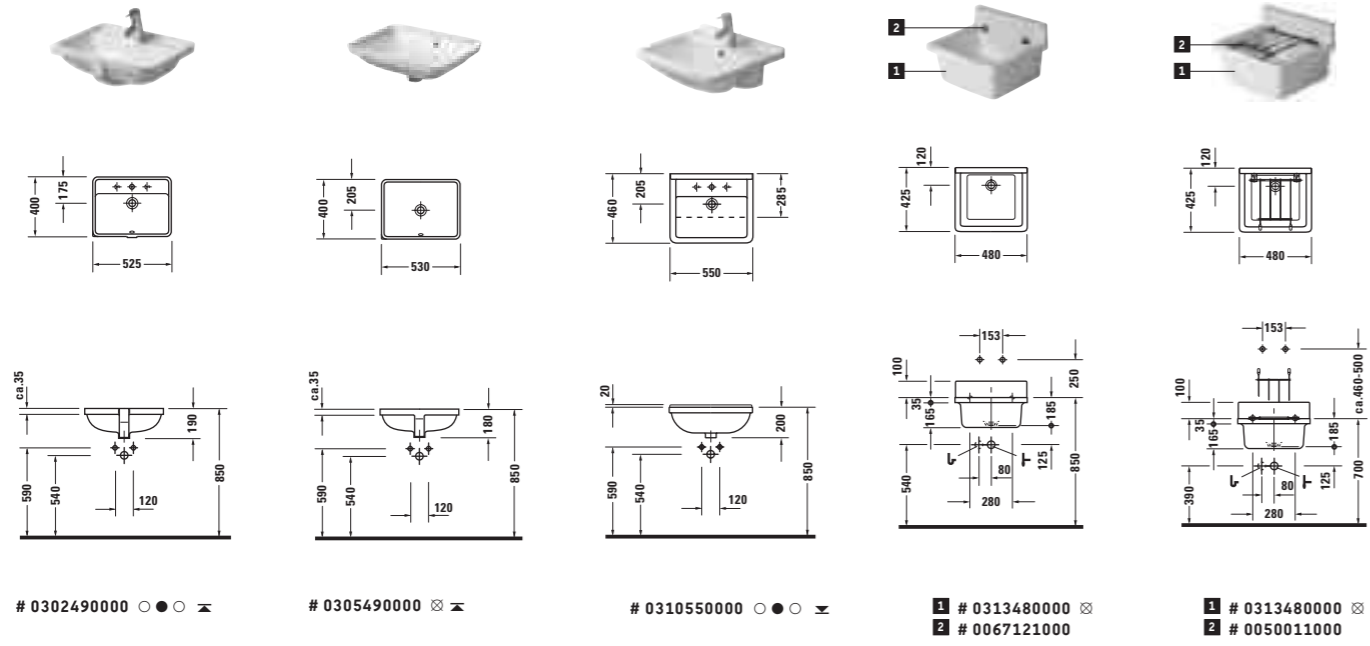

X yüksekliğe karar verebilmek için lütfen lavabo ve ayağı bera ber kullanın
+ ölçü tezgaha göre değişebilir
✕ Batarya deliksiz
● 1 armatür deliği açık
○ Sifon
T Dizayn Sifon
● Solda sonradan açılabilir delik
● Sağda sonradan açılabilir sabunluk deliği

○ ○ 1 armatür deliği açık, ilave olarak 2 adet armatür deliği açık olabilir (lütfen sipariş anında belirtiniz)
● ● ● 3 armatür deliği açık
✕ Tesisat aşağıdaki gibi
✕ Tesisat yukarıdaki gibi
○ Dikey çıkışı
♠ Yatay çıkışı
♣ Ekonomik 6 litre fonksiyon

→ Su girişi sol yan
← Su girişi sağ yan
↖ Su girişi arkadan
↙ Su girişi alt sol
Derinlik
↔ Genişlik
↔ Sol/Sağ
♠ ışıklandırılmalı

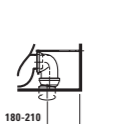
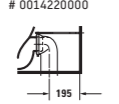
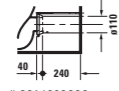
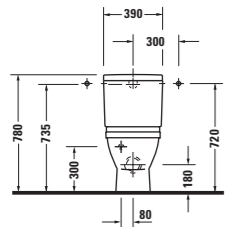
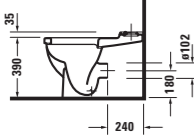
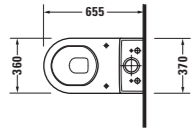

- 1 # 0063810000
- # 0063890000 (Soft close)
- 2 # 0128090000
- 3 # 0920000005
- # 0920100005

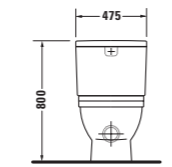
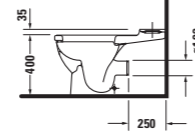
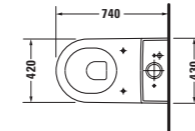

- 1 # 0067790000 (Soft close) / # 00677100000
- 2 # 2104090000
- 3 # 0928000005
- # 0928100005

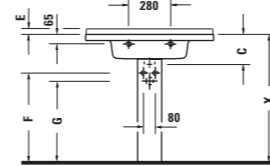
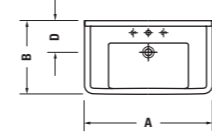
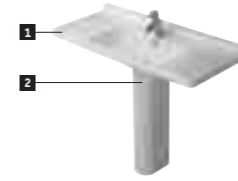

	A	B	C	D	E	F	G
1050 mm	1050	485	190	210	35	590	540
850 mm	850	485	190	210	35	590	540
700 mm	700	490	195	210	40	590	540

- 1 # 0304100000
- # 0304800000
- # 0304700000
- 2 # 0865160000

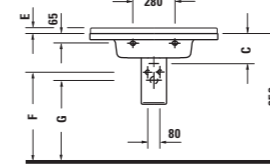
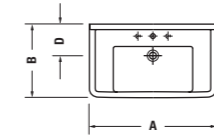
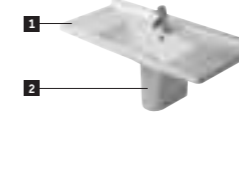

	A	B	C	D	E	F	G
1050 mm	1050	485	190	210	35	590	540
850 mm	850	485	190	210	35	590	540
700 mm	700	490	195	210	40	590	540

- 1 # 0304100000
- # 0304800000
- # 0304700000
- 2 # 0865150000

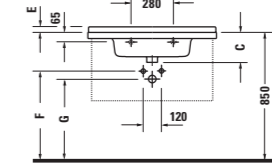
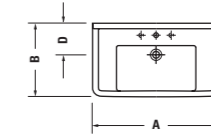

	A	B	C	D	E	F	G
1050 mm	1050	485	190	210	35	590	540
850 mm	850	485	190	210	35	590	540
700 mm	700	490	195	210	40	590	540

- # 0304100000
- Starck 1.2.3 # 6130
- X-Large # 6086
- # 0304800000
- Starck 1.2.3 # 6130
- X-Large # 6086
- # 0304700000
- Starck 1.2.3 # 6108
- X-Large # 6088, 6089

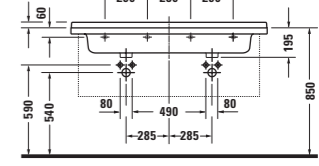
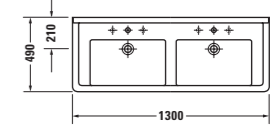

- # 0332130000
- # 0332130030
- Starck 1.2.3 # 6107,
- X-Large # 6067, 6068

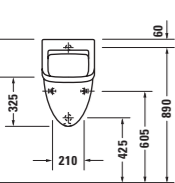
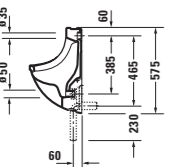
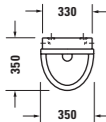

- # 0821350000
- # 0821350007
- # 0050421000
- Pisuar süzgeçi

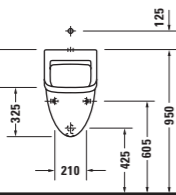
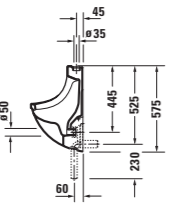
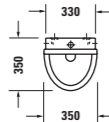

- # 0822350000
- # 0822350007
- # 0050421000
- Pisuar süzgeçi

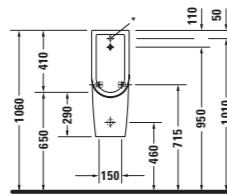
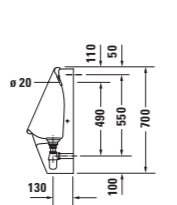
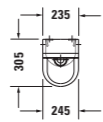

- # 0827250000
- # 0827250007
- * Su Girişi

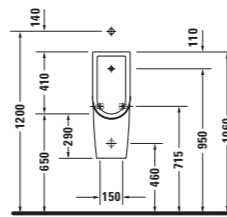
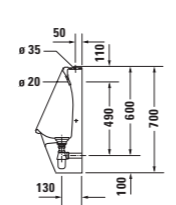

- # 0826250000
- # 0826250007

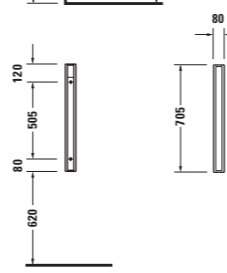
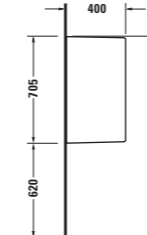
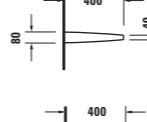

- # 8500000000

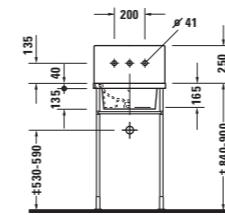
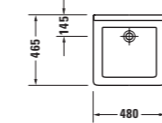
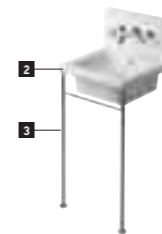

- 2 # 0306480000
- 3 # 0030641000

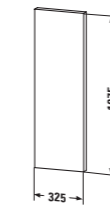

- ≥ 32mm
- # 9712
- # 9713
- ↔ 325 mm

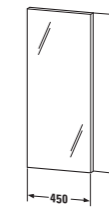

- ≥ 32mm
- # 9766
- # 9767
- ↔ 450 mm



Beyaz - 00

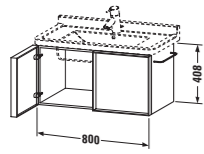

6130
↔ 800 mm, ↗ 479 mm
→ Starck 3 # 0304100000, 1050 mm
0304800000, 850 mm

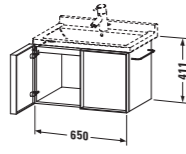

6108
↔ 650 mm, ↗ 479 (435) mm
→ Starck 3 # 0304700000, 700 mm

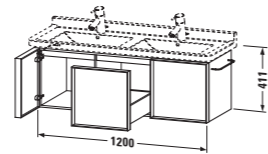

6107
↔ 1200 mm, ↗ 479 (435) mm
→ Starck 3 # 0332130000, 1300 mm

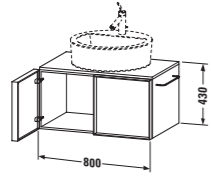

6165 Bagnella # 045140 400 mm # 6167 Starck 1 # 044546 600 mm
6165 Bagnella # 045148 480 mm # 6168 Vero # 045450 500 mm
6166 Bacino # 032542 420 mm # 6168 Vero # 045460 600 mm
6166 Bacino # 033342 420 mm # 6168 Vero # 045360 600 mm
6166 Bacino # 033452 550 mm # 6169 Vero # 045550 500 mm
6166 Starck 1 # 040853 530 mm # 6169 Vero # 045560 600 mm
6167 Starck 1 # 044753 530 mm ↔ 800 mm, ↗ 590 mm
6167 Starck 1 # 044648 480 mm

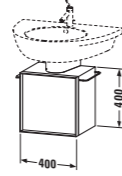

↗ 360 mm A
6190 L/R 145-170 mm
6191 L/R 196-220 mm
6192 L/R 221-255 mm
6193 L/R 171-195 mm
6194 L/R 256-285 mm

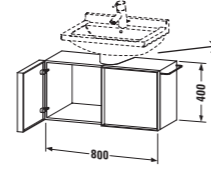

↗ 360 mm A
6195 145-170 mm
6196 196-220 mm
6197 221-255 mm
6198 171-195 mm
6199 256-285 mm

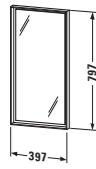

9605 ↗ 44 mm

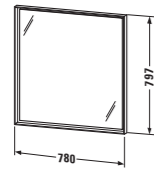

9606 ↗ 44 mm

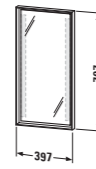

9608 ↗ 44 mm ☺

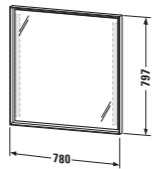

9609 ↗ 44 mm ☺

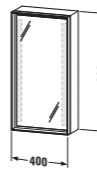

9778 L/R ↗ 194 mm ☺

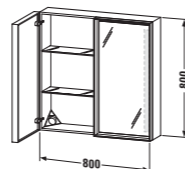

9779 ↗ 194 mm ☺

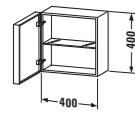

9403 L/R
↗ 194 mm

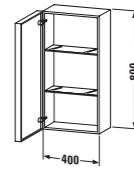

9404 L/R
↗ 194 mm

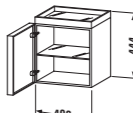

9333 L/R
↗ 194 mm

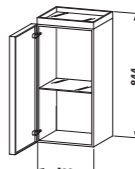

9334 L/R
↗ 194 mm

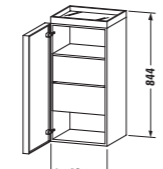

9335 L/R
↗ 194 mm

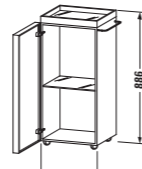

9337 L/R
↗ 194 mm

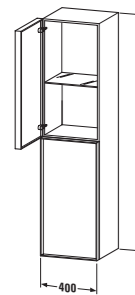

9236 L/R
↗ 394 mm

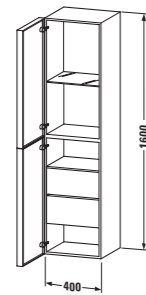

9237 L/R
↗ 394 mm

↗ Derinlik
↔ Genişlik
L/R Sol/Sağ
☺ ışıklandırılmalı

Dekor

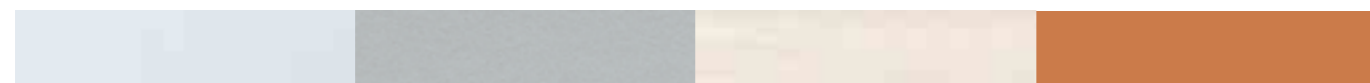

Hava Masajı
Küvetin tabanında sıcak hava üfleyen 12 adet jet.

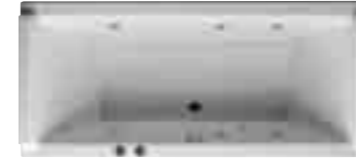

Su Jeti
Küvet yan duvarlarında kolaylıkla ayarlanabilen panel ile kumanda edilerek hassas masaj ve su terapisini başlatan 6 adet su jeti.

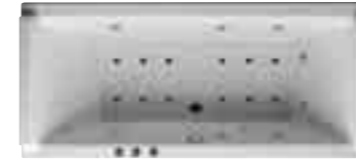

Combi Sistem P
Hava ve su jetinin mükemmel uyum içinde birleştirilmesi ile ikili karışımın sağladığı su terapisi. Sisteme ilave olarak ayak masajı için 2 adet dönerli su jeti. Bu işlevin küvet kenarına monte edilmiş hava düzenleyici ve 2 adet pinomatik kumanda düğmesi ile basıncı ayarlanabilir.

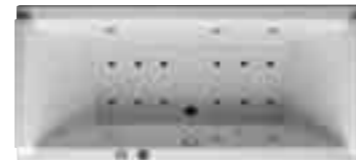

Combi Sistem E
Combi Sistem E'de elektronik kontrol paneli ile özel bir kumanda konforu ağırlanmaktadır. Elektronik kontrol paneli ile masaj etkisinin şiddeti, hava ve su jetlerin de ayrı ayrı ayarlanabilmektedir. Ayrıca elektronik kontrol panelinde standart olarak su ısısının artmasına karşı koruma sistemi mevcuttur. İsteğe bağlı olarak sırt ve ayak masaj jeteri, su ısıtıcı, hijyen ve temizlik ünitesi ve iç aydınlatma ilave edilebilir.

Combi Sistem E için opsiyonel modüller



Sırt masajı
Sırt için rahatlatıcı 3 adet ayarlı ve dönerli su jeti.



Ayak masajı
Ayaktaki uyarı refleks bölgeleri için 2 adet ayarlı ve dönerli su jeti.



İç aydınlatma
Banyonuzda sıcak bir ortam yaratan 1 adet 50 W gücünde halojen su altı lamba.



Isı
Isı kaybının ayarlanması, masaj esnasında elektronik ısıtma sistemi tarafından sağlanıyor.



Hijyen ünitesi
Püskürtme jetlerinde borularda ve dolaşım sisteminde dezenfeksiyon sağlayan elektronik kontrollü temizleme sistemi.

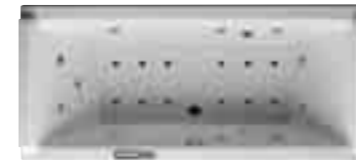

Combi Sistem L
Dokunulduğunda kontrol paneli mavi aydınlanıyor. Bu entegre kontrol paneli Hava ve Jet Sistemleri, halojen ışıklandırma, standart sırt ve ayak masajı fonksiyonlarının kolayca kumandası için. Bu standart ekipman küvet içinde su yokken jet sistemlerinin çalışmasını da önüyor. Combi Sistem L donanımına opsiyonel olarak, renkli ışıklandırma, ısıtma sistemi L, otomatik UV hijyen sistemi eklenebilir.

Combi Sistem L için opsiyonel modüller



Renkli ışıklandırma
Küvet yan panellerine yerleştirilmiş beş farklı spot ışık ile farklı renklerde veya istediğiniz sabit renkte banyo keyfinizi farklılaştırabilirsiniz.



Isıtma Sistemi L
LCD göstergeli özel ısıtma modülü. İstediğiniz sıcaklıkta banyo keyfi sürmenizi sağlar.



UV Hijyen Sistemi
Problemsiz, çevre duyarlılığına sahip mükemmel bir UV hijyen sistemi. Fonksiyonları kontrol paneli üzerinde görme kolaylığı.



700091 00 0 00 0000, 1500 x 700 mm
 # 700092 00 0 00 0000, 1500 x 750 mm
 # 700001 00 0 00 0000, 1600 x 700 mm
 # 700002 00 0 00 0000, 1700 x 700 mm
 # 700003 00 0 00 0000, 1700 x 750 mm
 # 700117 00 0 00 0000, 1700 x 800 mm
 # 700118 00 0 00 0000, 1700 x 900 mm
 Gömme (ankastre)

700091 00 0 00 0000, 1500 x 700 mm
 # 700092 00 0 00 0000, 1500 x 750 mm
 # 700001 00 0 00 0000, 1600 x 700 mm
 # 700002 00 0 00 0000, 1700 x 700 mm
 # 700003 00 0 00 0000, 1700 x 750 mm
 # 700117 00 0 00 0000, 1700 x 800 mm
 # 700118 00 0 00 0000, 1700 x 900 mm
 Ahşap panelli *

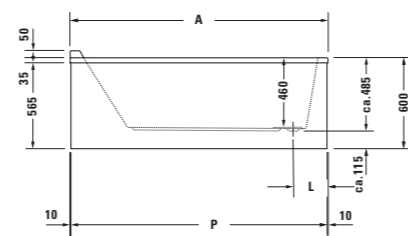
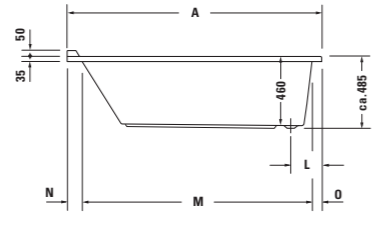
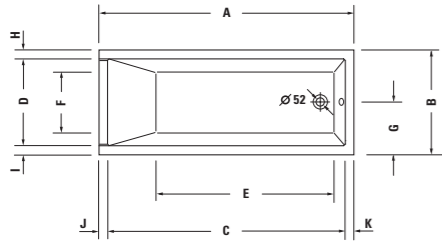

	A	B	C	D	E	F	G	H	I	J	K	L	M	N	O	P
#700091	1500	700	1370	570	980	400	350	65	65	65	230	1335	100	65	1480	
#700092	1500	750	1370	620	980	420	375	65	65	65	230	1335	100	65	1480	
#700001	1600	700	1470	570	1080	400	350	65	65	65	205	1435	100	65	1580	
#700002	1700	700	1570	570	1180	400	350	65	65	65	205	1535	100	65	1680	
#700003	1700	750	1555	590	1170	400	375	80	80	65	80	230	1515	105	80	1680
#700117	1700	800	1570	640	1180	460	400	80	80	65	65	230	1535	100	65	1680
#700118	1700	900	1570	740	1180	560	450	80	80	65	65	230	1535	100	65	1680

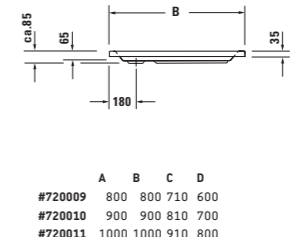
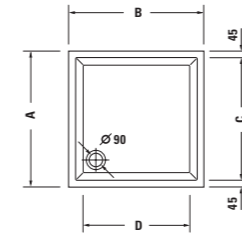

720009 00 0 00 0000, 800 x 800 mm
 # 720010 00 0 00 0000, 900 x 900 mm
 # 720011 00 0 00 0000, 1000 x 1000 mm

	A	B	C	D
#720009	800	800	710	600
#720010	900	900	810	700
#720011	1000	1000	910	800



700004 00 0 00 0000, 1800 x 800 mm
 # 700119 00 0 00 0000, 1800 x 900 mm
 # 700031 00 0 00 0000, 1900 x 900 mm
 # 700032 00 0 00 0000, 2000 x 1000 mm
 Gömme (ankastre)

700004 00 0 00 0000, 1800 x 800 mm
 # 700119 00 0 00 0000, 1800 x 900 mm
 # 700031 00 0 00 0000, 1900 x 900 mm
 # 700032 00 0 00 0000, 2000 x 1000 mm
 Ahşap panelli *

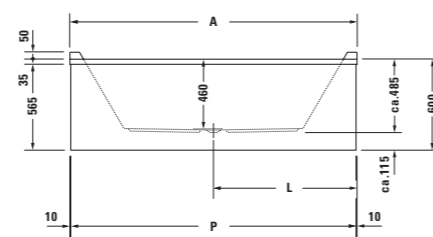
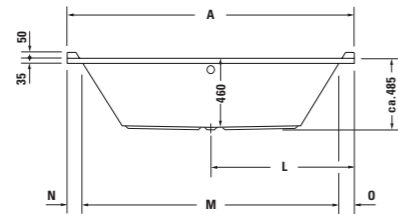
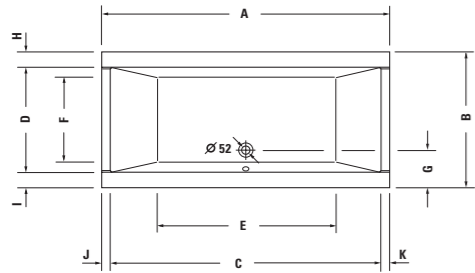

	A	B	C	D	E	F	G	H	I	J	K	L	M	N	O	P
#700004	1800	800	1670	640	1080	460	240	80	80	65	65	900	1590	105	105	1780
#700119	1800	900	1670	740	1080	560	240	80	80	65	65	900	1600	100	100	1780
#700031	1900	900	1770	700	1175	560	250	100	100	65	65	950	1690	105	105	1880
#700032	2000	1000	1870	800	1275	660	250	100	100	65	65	1000	1790	105	105	1980

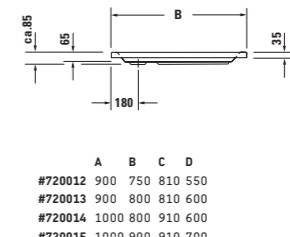
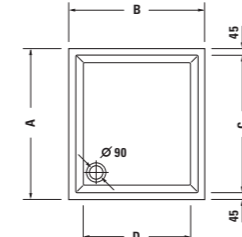

720012 00 0 00 0000, 750 x 900 mm
 # 700013 00 0 00 0000, 800 x 900 mm

720014 00 0 00 0000, 800 x 1000 mm
 # 720015 00 0 00 0000, 900 x 1000 mm

	A	B	C	D
#720012	900	750	810	550
#720013	900	800	810	600
#720014	1000	800	910	600
#720015	1000	900	910	700

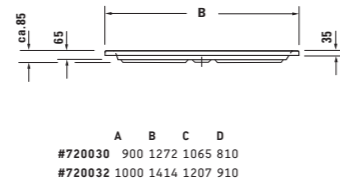
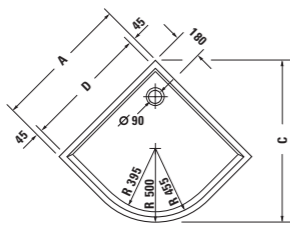

720030 00 0 00 0000, 900 x 900 mm
 # 720032 00 0 00 0000, 1000 x 1000 mm

	A	B	C	D
#720030	900	1272	1065	810
#720032	1000	1414	1207	910

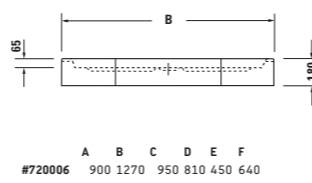
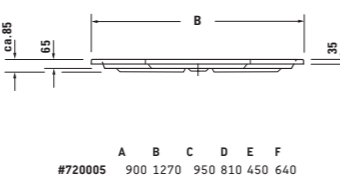
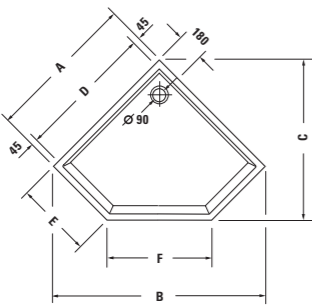

720005 00 0 00 0000, 900 x 900 mm
 # 720006 00 0 00 0000, 900 x 900 mm
 # 720007 00 0 00 0000, 1000 x 1000 mm
 # 720008 00 0 00 0000, 1000 x 1000 mm

	A	B	C	D	E	F
#720005	900	1270	950	810	450	640
#720007	1000	1410	1055	910	500	705

	A	B	C	D	E	F
#720006	900	1270	950	810	450	640
#720008	1000	1410	1055	910	500	705

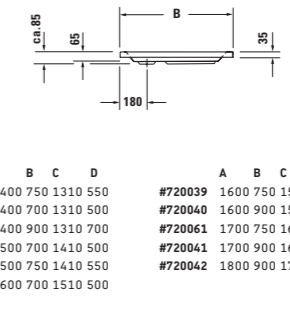
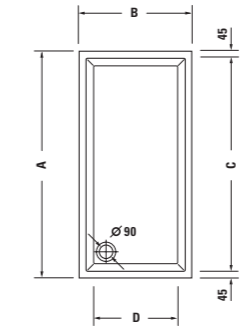





720019 00 0 00 0000, 1400 x 750 mm
 # 720034 00 0 00 0000, 1400 x 700 mm
 # 720035 00 0 00 0000, 1400 x 900 mm
 # 720036 00 0 00 0000, 1500 x 700 mm
 # 720037 00 0 00 0000, 1500 x 750 mm
 # 720038 00 0 00 0000, 1600 x 700 mm

720039 00 0 00 0000, 1600 x 750 mm
 # 720040 00 0 00 0000, 1600 x 900 mm
 # 720061 00 0 00 0000, 1700 x 750 mm
 # 720041 00 0 00 0000, 1700 x 900 mm
 # 720042 00 0 00 0000, 1800 x 900 mm





	A	B	C	D		A	B	C	D	
#720019	1400	750	1310	550		#720039	1600	750	1510	550
#720034	1400	700	1310	500		#720040	1600	900	1510	700
#720035	1400	900	1310	700		#720061	1700	750	1610	550
#720036	1500	700	1410	500		#720041	1700	900	1610	700
#720037	1500	750	1410	550		#720042	1800	900	1710	700
#720038	1600	700	1510	500						

* Starck Kvetler # 700117 # 700118 # 700119 # 700091 # 700092

Model-No. Ahşap Panel

	# 8910	# 8911	# 8912	# 8908	# 8909
	# 8917	# 8918	# 8919	# 8915	# 8916
	# 8924	# 8925	# 8926	# 8922	# 8923
	# 8938	# 8938	# 8939	# 8936	# 8936

Starck Kvetler # 700001 # 700002 # 700003 # 700004 # 700031 # 700032

	# 8785	# 8786	# 8787	# 8788	# 8906	# 8907
	# 8780	# 8781	# 8782	# 8783	# 8904	# 8905
	# 8775	# 8776	# 8777	# 8778	# 8902	# 8903
	# 8937	# 8938	# 8938	# 8939	# 8941	# 8942

Gerçek ahşap kaplama

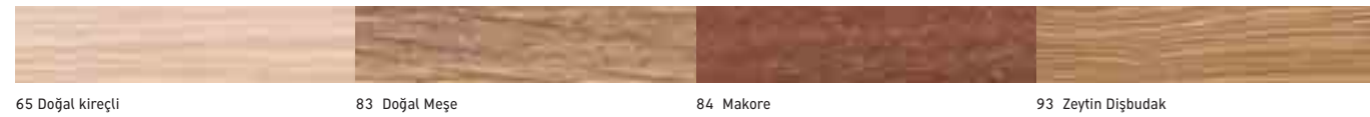
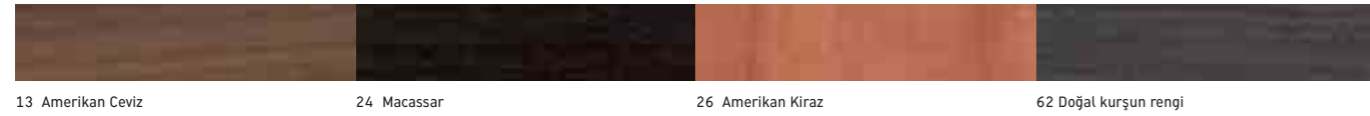

Dekor

